



Series 46.008.x06



Characteristics

- Direct controlled
- Plunger separated by diaphragm from medium
- Valve bodies can be connected
- Removable outlet nozzle
- Long term performance capability
- Flow rate adjustable (flow regulation screw)
- Suitable for food and hot water appliances
- Works from zero pressure
- Similar hydraulic performance for AC or DC types
- Other hydraulic connection on request
- Complete drainage of valve outlet after shut off
- Easy to assemble and service
- Coil change without opening of medium circuit, coil can be mounted 4 x 90°
- High operating safety through the use of high quality and 100% final testing of the products

Applications

- Hot / cold drink dispensers
- Tank or boiler draining
- Automatic animal feeding equipment

Description

2/2-way solenoid valve of nominal diameter DN 8 for liquid dispense. This valve is direct controlled and normally closed (NC).

Valves of this design are medium separated seat valves, where the plunger is separated by a diaphragm from the medium. Valve bodies can directly be connected. The valve outlet nozzle is removable.

This valve can be manufactured with a variety of customised connections in DC or AC voltage. Low power or PPM triggering can be used.

Electrical operating safety is achieved by PBT coating of the coil and can be supported by an additional protection circuit.

The valve is distinguished primarily by its food grade and hot water capability.

Possible approvals

Approved versions available on request:

- KTW/W270
- NSF 169
- WRAS
- UL
- Others on request

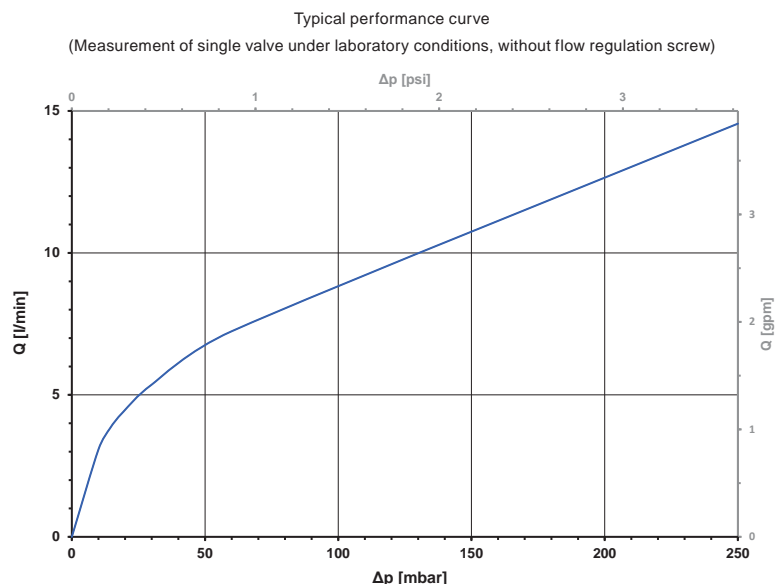



Series 46.008.x06

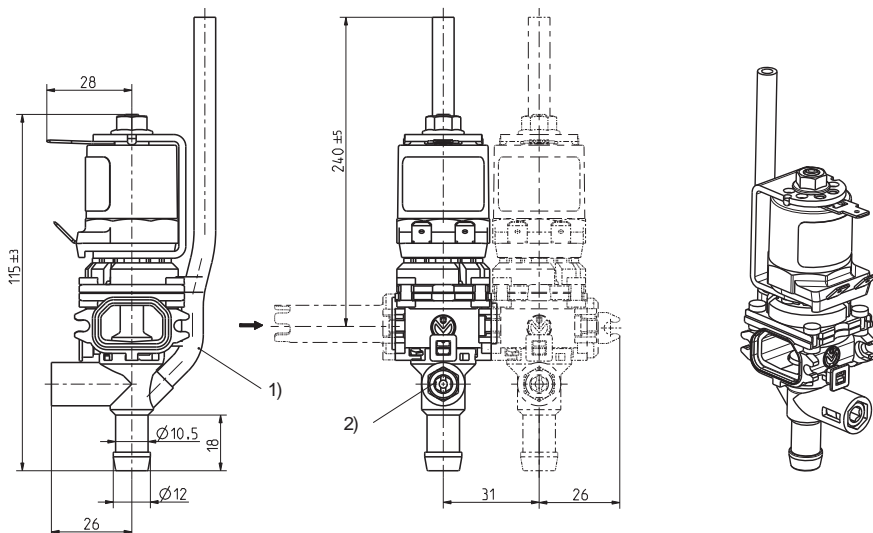

Technical Data

Type	dispense valve	
Construction	2/2-way single chamber valve inlet ninety degree to the outlet, direct acting, stackable	
Function	NC (normally closed)	
Fitting position	coil pointing upwards	
Media	cold and heated potable water and physically and chemically similar media	
T-Medium	98	°C
T-Ambient	70	°C
DN	8	mm
Flow	adjustable at nozzle	
p-Operating*	0 - 250	mbar
Coil type	MS.006, MS.024, MS.025	
Nominal voltages	230 V AC	50/60 Hz
	110 V AC	50/60 Hz
	24 V AC	50/60 Hz
	24 V DC	
	other voltages on request	
Voltage tolerance	+10% -15%	
Duty cycle	AC 50% (cycle 1 min) DC 100%	
Nominal power	9,5 W	16,4 VA (AC only)
Protection type	IP 00	higher IP-classes on request
Coil connection	flat tabs 6,3 x 0,8 mm (others on request)	
Insulation class	F	according to EN 60730
Protection class	I	according to EN 60730 (for incorporation in class I)

Materials

Valve body	PSU
Plunger guide	stainless steel
Plunger	stainless steel
Membrane	VMQ FMQ (on request)
Sealings	VMQ
Coil coating	PBT,PET or epoxy resin

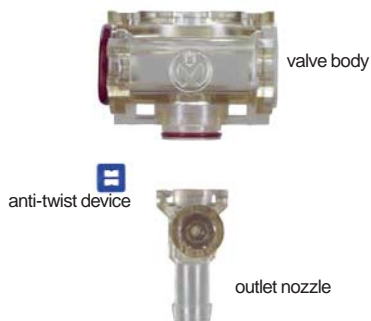

* The length of the breather pipe has to be adjusted according to the operating pressure.

Options

Name		Material
Closure		PSU
Valve body inlet adapter		PSU
Boiler connection		PSU
Inlet elbow nozzle		PSU

Name		Material
Backflow outlet nozzle		PSU
Backflow outlet elbow nozzle		PSU
Fixing Clip		PA 66
Other connections and outlet nozzles on request		

- 1) With or without ventilation of outlet nozzle to drain downstream tubing completely. Different lengths of breather tube on request.
- 2) With or without regulation screw for vernier adjustment of flow.

MS.006 (IP00)	
MS.024 (IP65)	
MS.025 (IP67, IP68)	



Series 46.008.x06

Housing variants

With regulation screw and ventilation

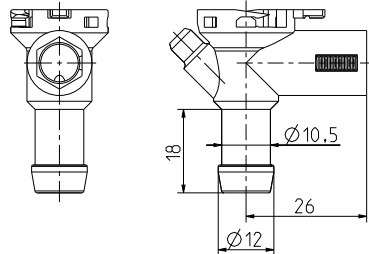

~001

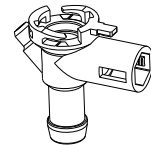

With regulation screw, without ventilation

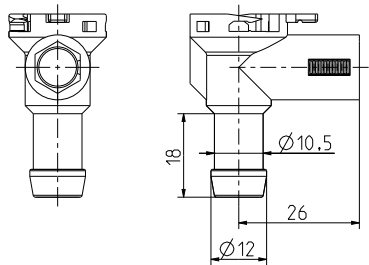

~002

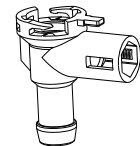

Without regulation screw, with ventilation

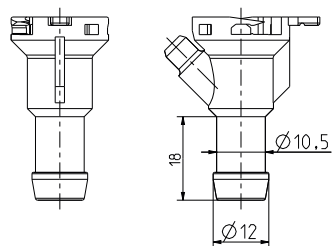

~003

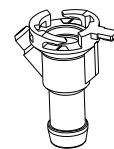

Without regulation screw and ventilation

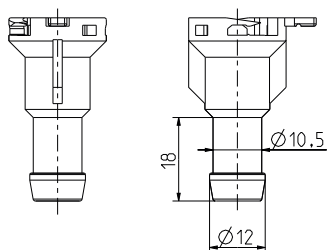

~004

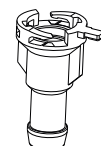



Series 46.008.x06



Solenoid valves
Control valves
Special valves and systems

A. u. K. Müller GmbH & Co. KG
Dresdener Str. 162
D-40595 Düsseldorf/Germany

Tel.: +49(0)211-7391-0
Fax: +49(0)211-7391-281

e-mail: info@akmueller.de
Internet: www.akmueller.de